

Trouble?

- 1) Be sure you have connected the CAT-5 cable correctly. Note that the stripe/solid pattern should match the labels on the product. Miss-wiring can cause distorted sound or prevent the system from working at all!
- 2) Be sure you have connected the speakers in phase. Follow the label on the product. Out of phase speakers can rob the system of its bass. Especially when driving dual-voice-coil speakers.
- 3) Be sure IR emitters are directly over the IR receiver for all devices you wish to control.

Specifications: (typical @25° C)

Operating Voltage :	24±.5VDC
Status input:	9-20VDC <20mA
Cable requirements:	CAT-5 or better
Speaker impedance:	6-8 ohm
IR repeating:	38-56kHz
IR sensor range (AB-114):	40'@40kHz 25'@56kHz
Operating Temperature:	-10°C to +50°C

Specifications subject to change without notice.

CHANNEL VISION Limited Warranty

Channel Vision Technology will repair or replace any defect in material or workmanship which occurs during normal use of this product with new or rebuilt parts, free of charge in the USA, for two years from the date of original purchase. This is a no hassle warranty with no mail in warranty card needed. This warranty does not cover damages in shipment, failures caused by other products not supplied by Channel Vision Technology, or failures due to accident, misuse, abuse, or alteration of the equipment. This warranty is extended only to the original purchaser, and a purchase receipt, invoice, or other proof of original purchase date will be required before warranty repairs are provided.

Mail in service can be obtained during the warranty period by calling (800) 840-0288 toll free. A Return Authorization number must be obtained in advance and can be marked on the outside of the shipping carton.

This warranty gives you specific legal rights and you may have other rights (which vary from state to state). If a problem with this product develops during or after the warranty period, please contact Channel Vision Technology, your dealer or any factory-authorized service center.

500-012 rev J1

CHANNEL VISION™

ABUS™ system

AB-114 / AB-202

AB-404 / AB-301

AB-T2454

Multi-room audio distribution system

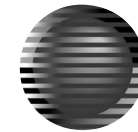
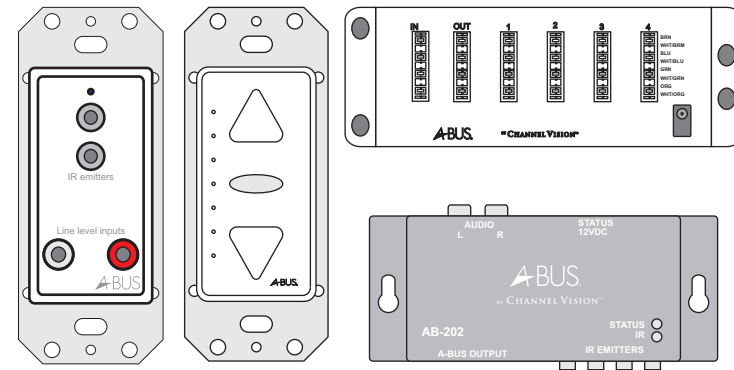

CHANNEL VISION™

234 Fischer Avenue · Costa Mesa, CA 92626
(714) 424-6500 · (800) 840-0288 · (714) 424-6510 fax
www.channelvision.com · email: sales @ channelvision.com

© 2004 Channel Vision Technology

The Channel Vision A-BUS system

can distribute high-quality audio to every room in your house over ordinary CAT5 data wire. Power for the entire system is delivered via the same CAT5 cable so only a single run of CAT5 is required. Each pair of speakers is powered and controlled from a local wall plate with a dedicated amplifier for that zone. Volume in that zone can be controlled manually or by an infrared remote. IR signals are also routed back to the source components enabling control of sources and functions from any zone.

Required components

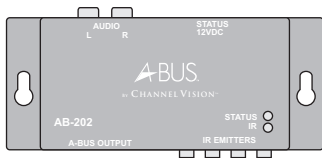

AB-202 ... Single source module. 1 per system. Interfaces sources to the system. Mount near audio components (CD player, receiver etc.)

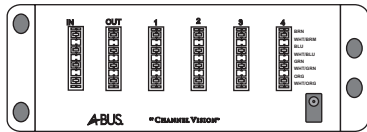

AB-404 ... Distribution module. 1 per every 4 amplified keypads. All CAT-5 cables terminate here. Also inserts power. Mount in a structured wire panel or screw to a wall. Compatible with panels from Channel Vision Central™, OpenHouse™, OnQ™, or Leviton™.

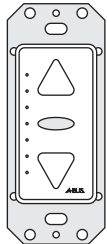

AB-114 amplified keypad ... 1 per speaker pair. Drives the speakers, controls volume and relays IR information. Mount the AB-114 in single gang low-voltage ring or deep J-box (if required by code). Blue LEDs show volume level. Keypad completely mutes when bottom LED is off. (No amplifier hiss like some other non-A-BUS systems.)

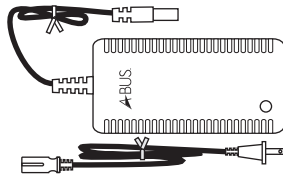

AB-T2454 ... Power supply. 1 per every AB-404. 120-240VAC

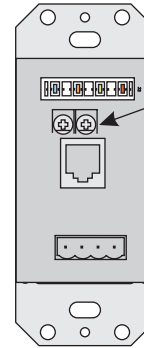

Balance ... The two potentiometers on the AB-114 adjust the volume levels of each speaker channel. Use these to adjust the speaker balance in this zone.

Gasket ... The AB-114 is shipped with a gasket. This allows you to adjust the height and fit of a decorator trim plate. Leave the gasket as is for a flush fit. Remove the gasket to have the AB-114 stand above the plate.

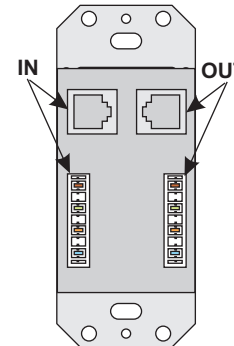
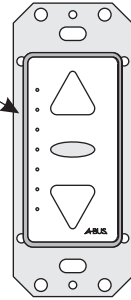

Input/Output ... To simplify installation, the AB-301 has both 110 and RJ-45 inputs and outputs. Only one of the inputs and one of the outputs should be used at a time.

Gasket ... The AB-301 is shipped with a gasket. This allows you to adjust the height and fit of a decorator trim plate. Leave the gasket as is for a flush fit. Remove the gasket to have the AB-301 stand above the plate.

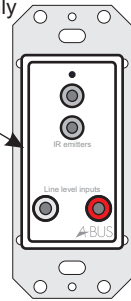

Suitable speakers

Channel Vision offers a variety of multi-room speakers.

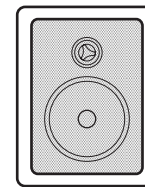

IW601
In-wall *Soprano* series
6.5" speaker

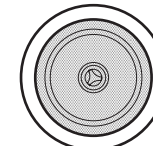

IC602
In-ceiling *Soprano* series
6.5" speaker

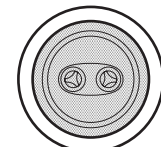

ID652
In-ceiling dual voice coil speaker
Both stereo channels from a single speaker. Steerable tweeters maintain the stereo image. Use in small rooms, bathrooms or hallways.

CAT-5 wiring details and options

Option ... If the modules are close together, cut a standard CAT-5 jumper in two pieces as shown.

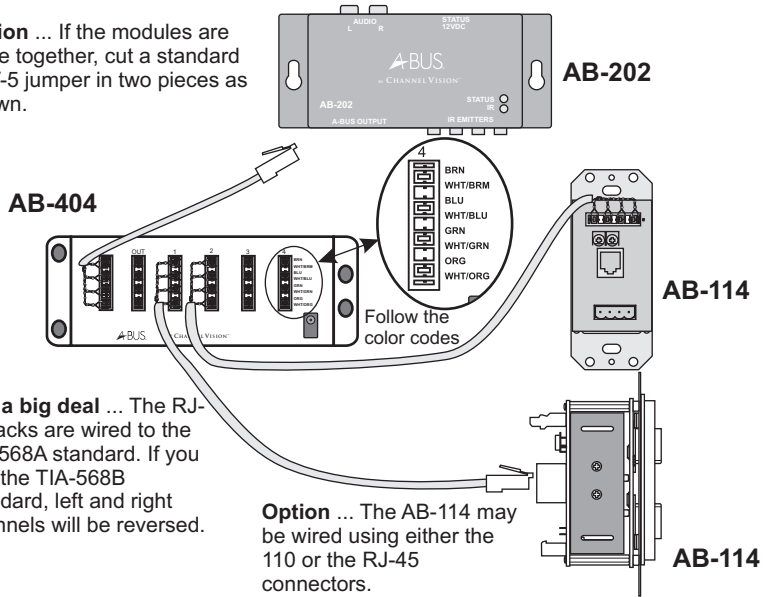

Not a big deal ... The RJ-45 jacks are wired to the TIA 568A standard. If you use the TIA-568B standard, left and right channels will be reversed.

Option ... Use CAT-5 jack to terminate cable from AB-404 and standard CAT-5 jumpers to connect AB-202.

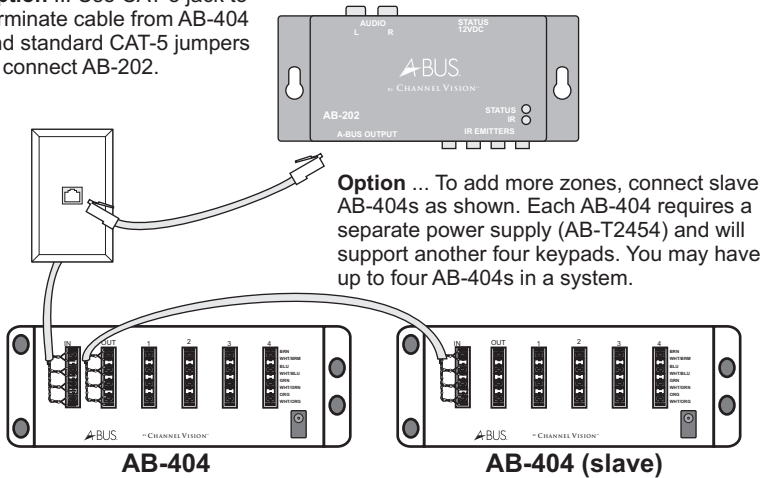

Optional components

AB-301 ... Universal input module. Can be used to provide local source input in any room and/or to replace the AB-202. The AB-301 is a great way to enable simple connection of local sources into the zone - TV's, MP3 players, computer sources, etc.

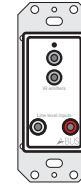

AB-500 ... Universal remote control. Comes pre-programmed to control the volume of the AB-114. Learns IR codes for up to 6 sources.

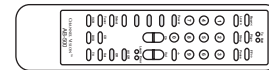

IR-3001 & IR-3002 ... Single and dual head IR flashers. Use one head per source to control from the remote room. (IR-3002 shown).

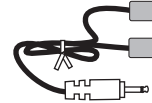

5019 ... Status power supply. Plugs into switched outlet of receiver. When the receiver is turned off, the entire system mutes. (If a supply is plugged into the status input, and is not powered, the system mutes.)

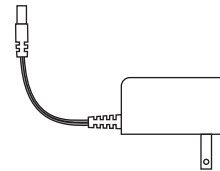

How IR repeating works

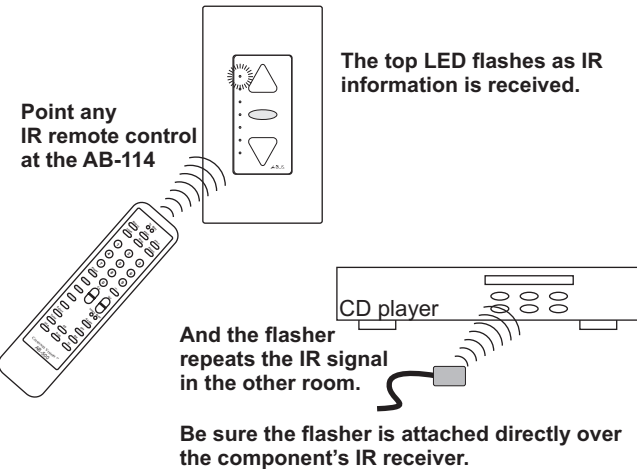

Basic system

In this system

Four rooms listen to the same audio program. Each room has independent volume controls.

Using the IR option, you can control the components from any room. You can change the system input from FM to the CD player, select another satellite radio station, or pause the CD.

Using the status option, the systems mutes and conserves power when the receiver is off. When the receiver is turned back on, all amplified keypads return to the last volume level.

(See corresponding numbers on opposite page)

- 1 **Loop out** ... Use this to expand to an additional AB-404. This connector only provides audio signals to an additional AB-404. It cannot be used to directly connect a 5th AB-114 to the system.
- 2 **Cat-5 cables** ... Follow color codes as shown. Use 110 punch down tool only. (Never use a screwdriver to punch down UTP wires. It will give intermittent connections and damage or destroy the 110 connector.)
- 3 **Volume indicators**... The LEDs indicate the volume level. If the Status is <off>, the LEDs will be dark. Pressing the UP/DOWN keys will light the LEDs for a short period to show the stored volume level.

Single zone system ... This is a single zone system. Even though there are 4 pairs of speakers being driven, there is only one source being fed to them at a time. All speakers play the same audio. Easy to use, single zone systems are ideal for all public spaces (kitchen, entry, family room, patio). Imagine walking from room to room and your music follows. If music is part of your life, the Channel Vision A-BUS system will make music a part of your house.

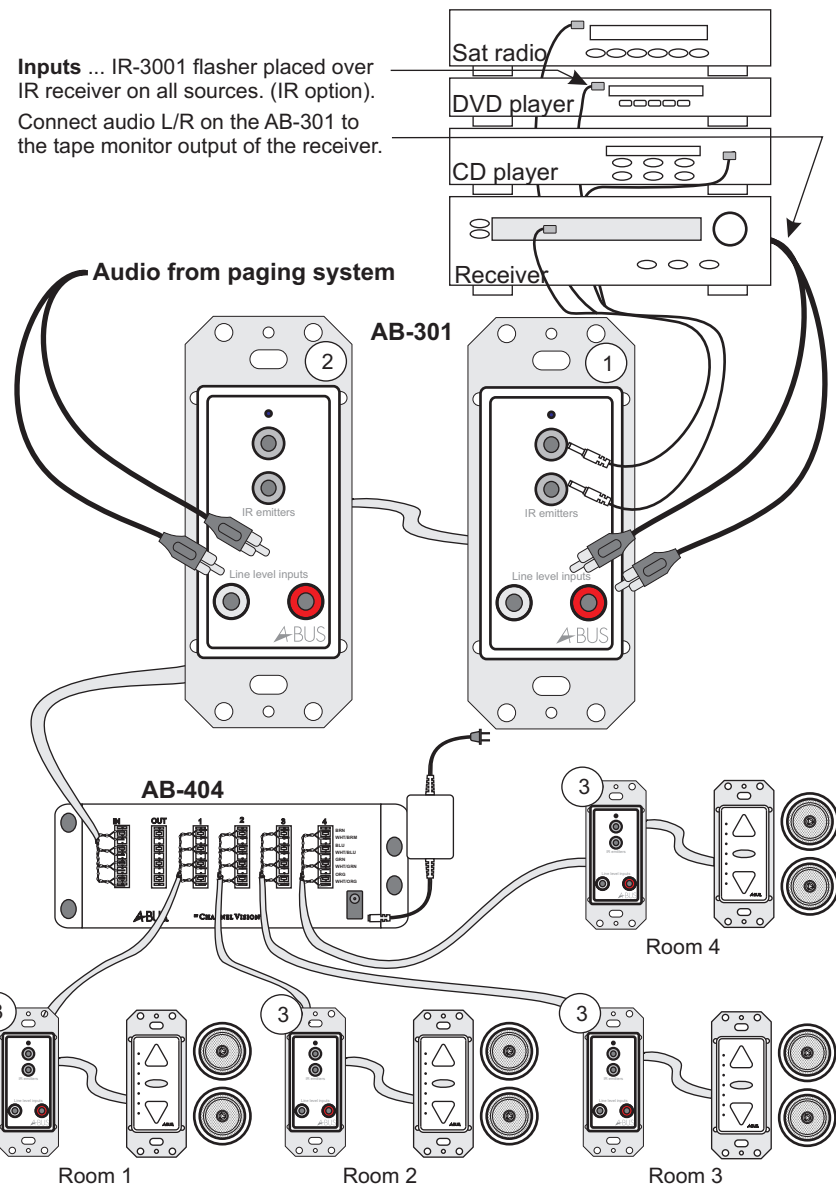

Advanced system

Using the AB-301 as a universal input module

In this system

The first AB-301 ① is used to input the main audio source. The second AB-301 ② is used to input audio from a paging system. The AB-301 in each room ③ is used to input audio that will only be heard in that room's speakers.

Using the IR option, you can control the components from any room. You can change the system input from FM to the CD player, select another satellite radio station, or pause the CD.

The AB-301 is activated by audio. The system mutes and conserves power whenever there is no audio feeding AB-301 ① or ②. When audio is present, all amplified keypads return to the last volume level.

More about paging

The second AB-301 ② will interrupt the audio from the first AB-301 ①, allowing a second audio source to be distributed to all of the rooms. This is perfect for phone systems that provide a line level output for paging.

Independent room inputs

The AB-301 in each individual room will interrupt all audio sources coming from the main system inputs. This includes the audio from a paging system. Therefore, if any of the rooms are using their individual AB-301 ③ they will not hear any announcements until they turn off the audio from their local source.

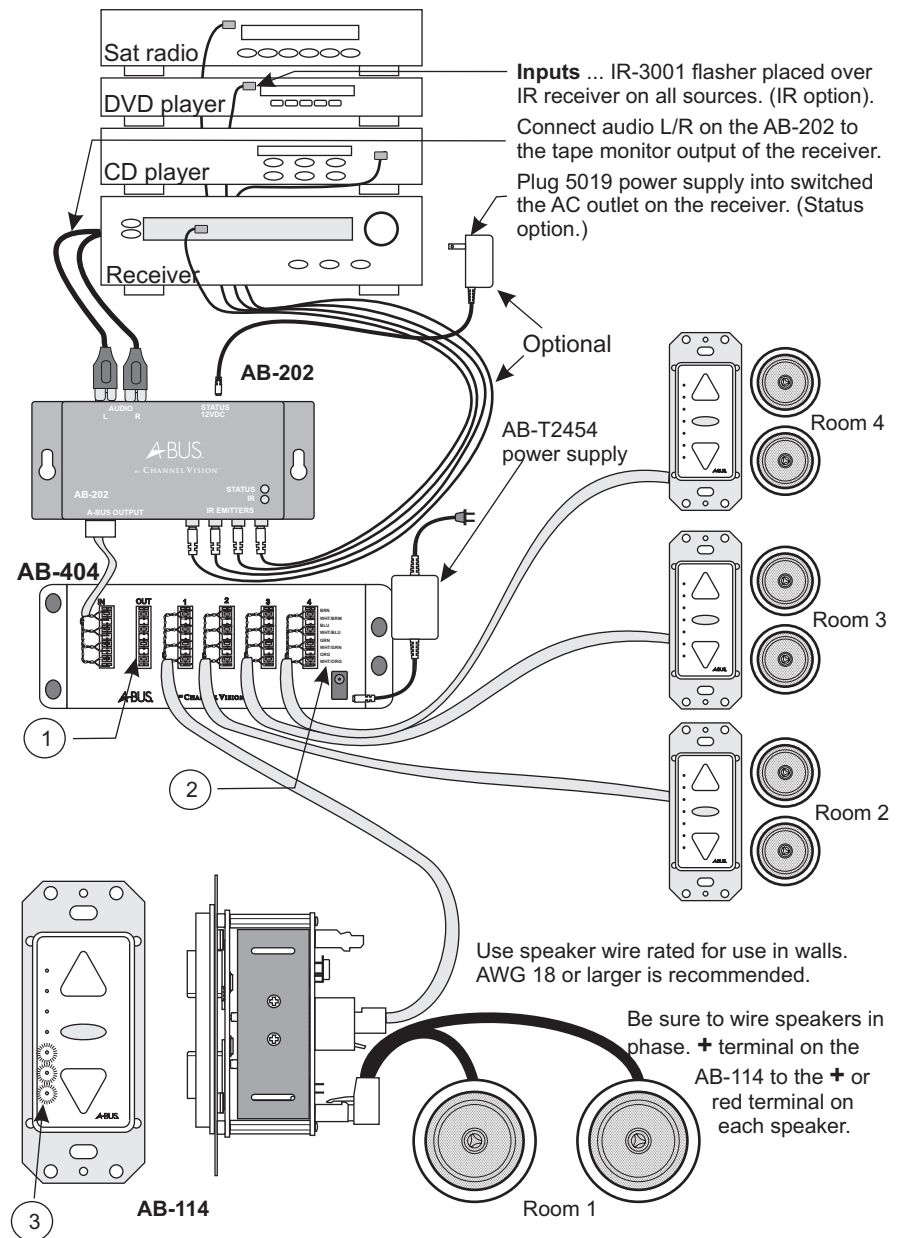

Advanced system

Using the AB-301 as a local source input module

